

Step Light Linear Recessed 210

GANL-GSLLR5210

- Corrosion resistant construction
- Multiple finishes
- Wide voltage range
- Energy efficient
- Easy to install
- Unique fixing system
- On board driver
- Fully serviceable

Installation – Concrete

Installation canister required for Concrete
 – Part No. GSLLRC5210-CANISTER
 (installation canister sold separately – See page 2).

Installation – Timber

Cut-out for 210mm Step Light is 190mm (W)
 x 30mm (H) x 70mm (minimum depth) to
 ensure sufficient space for connector and
 cable behind light fitting when installed.

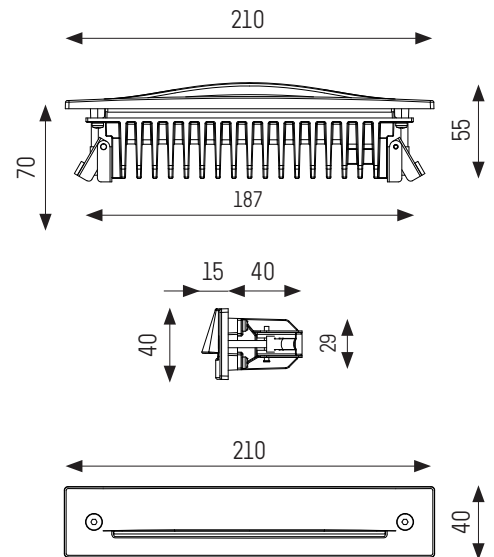

Specifications

- High output warm white Cree LED
- 5 watts total load
- 70 lumens per watt
- In-built thermal protection
- Power using a recommended 24VDC Power Supply
- IP rating – IP66
- Warranty – 5 years – applicable on purchases from 01/01/2019

MELBOURNE

1316 Malvern Road
 Malvern VIC 3144
 T 03 9824 4937
 vic@gan.com.au

SYDNEY

88 Alexander Street
 Crows Nest NSW 2065
 T 02 9439 9155
 nsw@gan.com.au

Specifications subject to change without notice

Step Light Linear Recessed-Installation Canister

GANL-GSLLRC5210-CANISTER

- Custom designed installation canister for GANL-GSLLR5210
- Suits off form concrete and masonry wall applications
- Side and rear conduit entry points
- Multiple fixing points
- Render collar included
- Easy to install

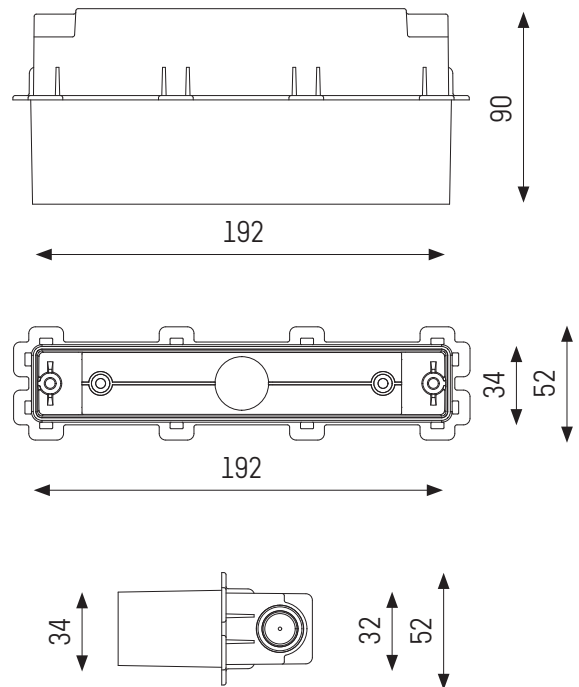

MELBOURNE

1316 Malvern Road
Malvern VIC 3144
T 03 9824 4937
vic@gan.com.au

SYDNEY

88 Alexander Street
Crows Nest NSW 2065
T 02 9439 9155
nsw@gan.com.au

Specifications subject to change without notice